

# HP Scanjet 7000/5000 Scanner

## User Guide





---

# Contents

<b>1 Scanner overview</b>	
Scanner hardware .....	3
Scanner front panel buttons .....	3
Scanner lamp setting .....	4
Scanner software .....	5
HP Smart Document Scan Software .....	5
HP Scanner Tools Utility .....	6
<b>2 Use the scanner</b>	
Load originals .....	7
Document loading tips .....	7
Load documents .....	9
Load cards into the document feeder .....	11
Scan and copy .....	11
Tips on scanning and copying .....	11
Scan from the scanner buttons .....	12
Scan from HP Smart Document Scan Software .....	12
Scan from ISIS- or TWAIN-compliant scanning software .....	12
<b>3 Useful scanner features</b>	
Work with scan profiles .....	14
View profiles .....	14
Create HP Smart Document Scan Software profiles .....	14
Create scan profiles that use third-party scanning software .....	15
Import and export HP Smart Document Scan Profiles .....	15
Scan extra long documents .....	15
Reduce file size with hardware compression .....	16
Filter out color from a document (color dropout) .....	17
Hardware Misfeed (Multipick) Detection .....	17
<b>4 Care and maintenance</b>	
HP Scanner Tools Utility Maintenance tab .....	19
Order maintenance and scanning supplies .....	19
Clean the scanner glass .....	19
Clean the paper path .....	20
Clean the rollers .....	21
Replace the rollers .....	24
<b>5 Troubleshooting</b>	
Scanner error codes .....	26
Basic troubleshooting tips .....	27
Scanner installation troubleshooting .....	28
Check the cables .....	28
Uninstall and then reinstall the HP Scanjet utilities .....	28

Scanner initialization or hardware problems .....	29
Check the USB connection .....	29
Check that the scanner has power .....	29
Reset the scanner .....	30
Scanner has stopped working correctly .....	30
Scanner operation problems .....	31
Scanner will not turn on .....	31
Scanner lamp stays on .....	31
Scanner does not scan right away .....	32
Scanner scans only one side of a two-sided page .....	32
Scanned pages are missing at the scan destination .....	32
Scanned image is fuzzy .....	32
Scanned pages are out of order at the scan destination .....	33
Optimize scanning and task speeds .....	33
The scan is completely black or completely white .....	33
Scanned images are not straight .....	34
Vertical white stripes appear on the printed page .....	34
Scan files are too large .....	34
Scanner buttons are not working correctly .....	34
Scanner paper path problems .....	35
Paper jamming, skewing, misfeeds, or multiple-page feeds .....	35
Scanning fragile originals .....	36
Paper does not feed from the scanner .....	36
Originals are curling up in the scanner output tray. ....	36
The bottom of the scanned image is cut off .....	37
The scanned images have streaks or scratches .....	37
An item loaded in the scanner jams repeatedly .....	37
Clear jams from the scanner paper path .....	38
Contact HP Support .....	39
<b>6 Product accessibility and support</b>	
LCD Reader .....	40
Control of the scanner buttons .....	40
Getting assistance .....	41
<b>Index</b> .....	42

# 1 Scanner overview

This User Guide covers what you need to know about using your scanner.

- [Scanner hardware](#)
- [Scanner software](#)

## Scanner hardware

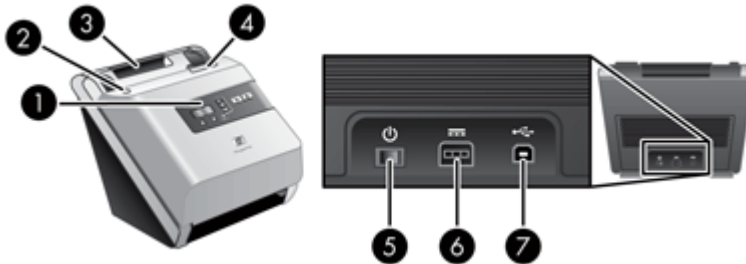

1	Front panel
2	Power save button
3	Document feeder
4	Latch to open scanner
5	Power switch
6	Power supply input
7	USB input







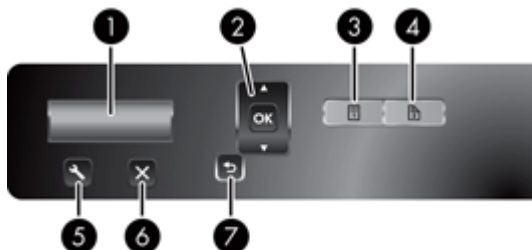

See also

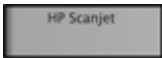
- [Scanner front panel buttons](#)
- [Scanner lamp setting](#)

## Scanner front panel buttons

Use the buttons on the scanner front panel to start a scan and to configure some scanner settings.



Icon	Button name	Description
1 	<b>LCD</b>	<ul style="list-style-type: none"> <li>Displays available scan profiles and status and error messages.</li> <li>Displays the number of copies you specified for copying.</li> </ul>
2 	<b>OK/Select</b>	<p>Allows you to scroll the list of scan profiles, view their details, and specify the number of copies.</p> <ul style="list-style-type: none"> <li>Press ▲ and ▼ to scroll through profiles or specify number of copies.</li> <li>Press <b>OK</b> to view scan profile details, return to the list of profiles when viewing scan profile details, and to specify the number of copies for a copy profile.</li> </ul>
3 	<b>Scan Simplex</b>	Starts a one-sided scan or copy.
4 	<b>Scan Duplex</b>	Starts a two-sided scan or copy.
5 	<b>Tools</b>	<p>Opens the HP Scanner Tools Utility where you can perform the following tasks:</p> <ul style="list-style-type: none"> <li>Configure the list of profiles on the scanner front panel</li> <li>Create scan profiles that use third-party scanning software</li> <li>View information about scanner settings, status, and maintenance</li> </ul>
6 	<b>Cancel</b>	Cancels a scan or copy in progress.
7 	<b>Back</b>	<p>Returns you to the list of profiles when you are viewing profile details or specifying number of copies for a copy profile. Pressing  when specifying number of copies cancels your selection.</p>

See also

- [Scanner error codes](#)
- [Useful scanner features](#)

## Scanner lamp setting

The scanner supports two modes of lamp operation:

- In Power Save mode, the scanner lamp times out and turns off automatically after about 15 minutes of inactivity. If the scanner lamp has turned off and you want to scan, either press the **Power Save** button or load originals into the document feeder.
- In Instant Lamp On mode, the scanner lamp times out and turns off automatically after about 15 minutes of inactivity, but it remains warm and ready to scan.

To switch from Power Save mode to Instant Lamp On mode, select the **Enable Instant Lamp On** check box on the **Settings** tab of the HP Scanner Tools Utility. To switch back to Power Save mode, clear the **Enable Instant Lamp On** check box.

## Scanner software

The scanner comes with an assortment of scanning and document-management programs, including:

- [HP Smart Document Scan Software](#)
- [HP Scanner Tools Utility](#)

### HP Smart Document Scan Software



HP Smart Document Scan Software guides you through the scanning process. To open the software, double-click the **HP Smart Document Scan Software** icon on the desktop. For more information, see the HP Smart Document Scan Software Help.

#### Main Window

The Main Window is displayed when you open the HP Smart Document Scan software. Use this window to complete the following tasks:

- **Start a scan:** Load the original in the document feeder, select a profile, and then click **Scan**. The scan will be completed using the settings associated with the selected profile.
- **Work with profiles:** Create and modify profiles to specify the scanner settings and the actions to take on your scanned documents.

#### Scan Progress Window

The Scan Progress Window opens when you start a scan. Use this window to complete the following tasks:

- View thumbnails of the pages as they are scanned
- Scan more pages
- Rescan pages individually
- Edit pages individually to crop, rotate, and deskew the images.
- Reorganize or delete pages
- Complete the scan and process the document

For more information, click **Help** on the HP Smart Document Scan Software menu bar.

## HP Scanner Tools Utility

Use the HP Scanner Tools Utility to configure the list of scan profiles on the scanner front panel, to create scan profiles that use third-party scanning software, and to find information about scanner settings, status, and maintenance.



To open the utility, do one of the following:

- Double-click the **HP Scanner Tools Utility** icon on the desktop.
- Press the **Tools**  button on the scanner front panel.
- Click **Start**, point to **Programs** or **All Programs**, point to **HP**, point to **Scanjet**, point to **7000** or **5000**, and then click **HP Scanner Tools Utility**.

For more information, see the HP Scanner Tools Utility Help.



---

## 2 Use the scanner

The following topics describe the HP Scanjet scanner as well as how to scan or copy original documents.

- [Load originals](#)
- [Scan and copy](#)

### Load originals

For helpful information on loading your documents properly, refer to the following topics.

- [Document loading tips](#)
- [Load documents](#)
- [Load cards into the document feeder](#)

### Document loading tips













- The maximum capacity of the document feeder is 50 sheets of 75 g/m<sup>2</sup> (20 lb) paper. When using heavier paper, the maximum capacity is decreased.
- The card capacity of the document feeder is 10 cards.
- Be sure that your documents are within these guidelines:

Width:	52 mm to 216 mm (2.1 in to 8.5 in)
Length:	74 mm to 864 mm (2.9 in to 34 in)
Weight:	50 g/m <sup>2</sup> to 120 g/m <sup>2</sup> (13.3 lb to 32 lb)

- In the scanning software, set the page size to match the width and length of the paper that you are scanning.
- The scanner document feeder can process cards that meet the following specifications:

Minimum size:	52 mm x 74 mm (2.1 in x 2.9 in)
Maximum size:	210 mm x 269 mm (8.3 in x 10.6 in)
Minimum weight:	253 g/m <sup>2</sup> (12 points or 102 lb)
Maximum weight:	326 g/m <sup>2</sup> (15 points or 120 lb)

- Scanning the following types of documents might result in paper jams or damage to the documents.

	Wrinkled or creased documents		Curled documents
	Torn documents		Documents with paper clips or staples
	Carbon paper		Coated paper
	Extremely thin, translucent paper		Paper with adhesive notes or flags attached
	Photos		Overhead transparencies
	Papers that are stuck together		Paper with wet substances such as glue or correction fluid

- Smooth out any folds or curls in your documents before placing them into the feeder. If the leading edge of a document is curled or folded, it may cause a paper jam.
- When loading paper that is smaller than 74 mm (2.9 in) in one dimension (such as business cards), place the pages with the long side parallel to the paper guides.
- To scan fragile documents (such as photos or documents on wrinkled or very lightweight paper), place the document in a clear, heavyweight document sleeve no wider than 216 mm (8.5 in) before loading them into the document feeder.

 **TIP:** If you do not have an appropriately-sized document sleeve, consider using a sleeve intended for use in a ring binder. Trim the ring-side edge so the sleeve is no more than 216 mm (8.5 in) wide.

- Make sure that the hatch on the document feeder is securely latched. To properly close the hatch, press until you hear a click.
- Adjust the paper guides to the width of the documents. Make sure that the paper guides touch the edges of the original. If there is any clearance between the paper guides and the edges of the documents, the scanned image might be skewed.
- When placing a stack of documents into the feeder, gently set the stack in the document feeder. Do not drop the stack into the feeder and do not tap the top edge of the stack after you have placed the stack in the document feeder.
- Clean the scanning rollers if the rollers are visibly dirty or after scanning a document that has pencil writing on it.

See also

[Clean the paper path](#)

[Clean the rollers](#)

[Scanner paper path problems](#)

## Load documents

1. Pull up the document feeder extension and adjust the output tray.



2. Adjust the paper guides to the width of the documents. Take care not to overtighten the guides, which can restrict paper feeding.



When scanning small originals such as checks, it is especially important that the paper guides fit snugly against the edges of the original.

3. Fan the stack of document pages to ensure that the pages do not stick together. Fan the edge that will be pointing into the feeder in one direction, and then fan that same edge in the opposite direction.



4. Align the edges of the documents by tapping the bottom of the stack against the table top. Rotate the stack 90 degrees and repeat.

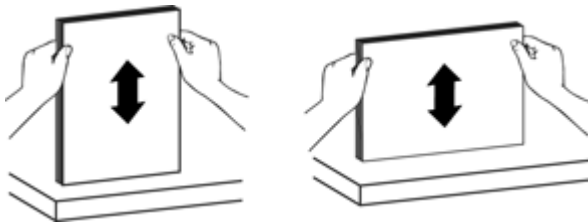

5. Gently set the stack in the document feeder. Load the pages face down with the top of the pages pointing into the feeder.  
*For best results, do not drop the stack into the feeder and do not tap the top edge of the stack after you have placed it in the document feeder.*



6. Verify that the paper guides are aligned with the edges of the stack.

## Load cards into the document feeder

To load cards into the document feeder, follow these steps:

1. Place the stack of cards face down with the long dimension parallel to the paper guides.



2. Adjust the paper guides to center the original. Make sure the paper guides touch the edges of the original.

## Scan and copy

The following topics describe how to scan or copy originals using the scanner and the scanner software.

- [Tips on scanning and copying](#)
- [Scan from the scanner buttons](#)
- [Scan from HP Smart Document Scan Software](#)
- [Scan from ISIS- or TWAIN-compliant scanning software](#)

### Tips on scanning and copying

- If the scanner LCD does not display any scan or copy profiles, open the HP Scanner Tools Utility to load the profiles onto the scanner.
- To reduce paper jams, use scan settings that specify the actual dimensions of the pages that you are scanning.
- To cancel a scan or copy, press **Cancel** (X).
- If you press **Scan Duplex** (H), the scanner processes both sides of the original regardless of the scan profile setting. If you press **Scan Simplex** (I), the scanner processes only one side of the original.

- If you want to change the copy settings, select **Start copy software** and then press either the **Scan Simplex** (☐) or **Scan Duplex** (☐) button. The HP Copy software starts on the connected computer where you can modify copy settings.
- You can create scan profiles that use third-party scanning software. For more information, see the HP Scanning Tools Utility Help.

### Scan from the scanner buttons

To scan using the scanner buttons, follow these steps:

1. Load the originals.
2. Use ▲ and ▼ to select the scan or copy profile you want.
3. If you selected a copy profile, press **OK**, use ▲ and ▼ to specify the number of copies you want, and then press **OK**.

---

☼ **TIP:** If you selected a scan profile, pressing **OK** displays the scan profile's file type, color mode, and resolution. To return to the profiles list, press ↶.

---

4. Press either **Scan Simplex** (☐) for one-sided scans or **Scan Duplex** (☐) for two-sided scans.

### Scan from HP Smart Document Scan Software

You can start a scan from the HP Smart Document Scan Software.

1. Do one of the following:
  - Double-click the **HP Smart Document Scan Software** icon on the computer desktop.



- Click **Start**, point to **Programs** or **All Programs**, point to **HP**, point to **Scanjet**, and then click **HP Smart Document Scan Software**.
2. Select a profile, and then click **Scan**.

---

☼ **TIP:** A description of the selected profile is displayed below the list.

---

3. Follow the onscreen instructions to complete the scan.

For more information, see the HP Smart Document Scan Software Help.

### Scan from ISIS- or TWAIN-compliant scanning software

You can scan an image or document directly into a software program if the program is ISIS or TWAIN compliant. Generally, the program is compliant if it has a menu option such as **Acquire**, **Scan**, **Import New Object**, or **Insert**. If you are unsure whether the program is compliant or what the option is, see the documentation for that program.

1. Start the scanning software, and then select the ISIS or TWAIN data source.
2. Select the settings that are appropriate for the documents that you are scanning.
3. Carry out the appropriate actions to complete the scan.

For more information, see the online help for the scanning software.

---

## 3 Useful scanner features

Experienced document management professionals might be interested in the following scan features. These features are available from any document TWAIN or ISIS application that allows you to modify the scan settings in its user interface.

- [Work with scan profiles](#)
- [Scan extra long documents](#)
- [Reduce file size with hardware compression](#)
- [Filter out color from a document \(color dropout\)](#)
- [Hardware Misfeed \(Multipick\) Detection](#)

### Work with scan profiles

Scan profiles provide a fast, efficient way to select the settings for frequently-performed scanning tasks.

- You can use the HP Smart Document Scan Software to set up and modify profiles.
- You can use the Scanner Tools Utility to create profiles associated with ISIS- or TWAIN-compliant third-party applications, and to populate the scanner LCD list.

### View profiles

To view the existing HP Smart Document Scan Software profiles, follow these steps:

1. Click **Start**, point to **Programs** or **All Programs**, point to **HP**, point to **HP Smart Document Scan**, and then click **HP Smart Document Scan Software**.
2. View the list of profiles.

To view all existing scan profiles, follow these steps:

1. Turn on the scanner and start the HP Scanner Tools Utility.
2. Click the **Profiles** tab.

### Create HP Smart Document Scan Software profiles

To create an HP Smart Document Scan Software profile, follow these steps:

1. Click **Start**, point to **Programs** or **All Programs**, point to **HP**, point to **HP Smart Document Scan**, and then click **HP Smart Document Scan Software**.
2. Click **New**.  
The **Create New Profile** dialog box is displayed.
3. In the **Profile name** box, type the name you want or accept the default name.

---

 **TIP:** You might want to set up the new profile based on an existing one. To do so, select the **Copy settings from profile** check box, and then select an existing profile from the list.

---

4. Click **Continue**.  
The **Profile Settings** dialog box is displayed.
5. Select the settings for the profile.



For more information, see the HP Smart Document Scan Software Help.

## Create scan profiles that use third-party scanning software

If you have scanning software that you want to use with your scanner, you can create profiles that use your software.

To create a third-party scan profile, follow these steps:

1. Turn on the scanner and start the HP Scanner Tools Utility.
2. Click the **Profiles** tab.
3. In the **Other application profiles** area, click **Create**.
4. Complete the fields in the **Create Other Application** dialog box.
  - **Application:** Enter the complete path and filename of the scanning software you want to use, or click **Browse** to locate and select it.
  - **Title:** Enter a name for this profile as you want it to display in the scanner LCD list. You can enter up to 32 characters (16 for double-byte languages such as Chinese and Korean).
  - **Details:** Enter a description of up to 24 characters (12 for double-byte languages).
5. **Command Line for Simplex Button** and **Command Line for Duplex Button:** If your scanning application supports specific command line parameters for scanning, enter them here.
6. When you are done, click **OK**.

---

 **TIP:** If you later want to edit or delete the third-party profile you created, click either **Edit** or **Delete** in the **Other application profiles** area on the **Profiles** tab.

---

## Import and export HP Smart Document Scan Profiles

Profiles can be exported into and imported from an XML file so that administrators can set up profiles for a workgroup, users can transfer their profiles from one machine to another, and users can share custom profiles with each other.

## Scan extra long documents

By default, the HP Smart Document Scan Software accepts a stack of originals up to 216 mm x 356 mm (8.5 in x 14 in). You can choose to scan single pages up to 216 mm x 864 mm (8.5 in x 34 in).

---

 **NOTE:** If the scanner is set to scan long pages and a page jams, up to 864 mm (34 in) of document pages can be wrinkled as a result of the jam. Therefore, select scan profiles that specify long pages only when you are scanning pages longer than 356 mm (14 in).

---

To enable long-page scans in an HP Smart Document Scan Software profile, follow these steps:

1. Open the HP Smart Document Scan Software.
2. Select a scan profile, and then click **Edit**.
3. Set the page size:
  - ▲ On the **Scan** tab of the **Profile Settings** dialog box, select **Custom** in the **Size** drop-down list, and then type the actual page dimensions, up to 216 mm x 864 mm (8.5 in x 34 in), in the **Width** and **Height** boxes.

---

 **TIP:** Alternatively, you can select **Maximum** in the **Size** drop-down list. The resulting scanned image size will be 216 mm (8.5 in) wide and the actual page length up to 864 mm (34 in) long.

 **NOTE:** In other scanning software, the page size settings are on the **Layout** tab of the ISIS or TWAIN **Advanced Settings** dialog box.

**NOTE:** Some scanning and destination software might not support all of the page sizes that the scanner accepts.

**NOTE:** HP recommends scanning long pages individually at a resolution of 300 dpi or lower.

---

## Reduce file size with hardware compression

The scanner supports multiple levels of JPEG compression to increase the rate of data transfer from the scanner to the scanning software on the computer. The scanner compresses the data during the scanning process. The scanning software can uncompress the data in order to create scanned images. JPEG compression works on grayscale and color scans.

To enable JPEG compression in an HP Smart Document Scan Software profile, follow these steps:

1. Open the HP Smart Document Scan Software.
2. Select a scan profile, and then click **Edit**.
3. Turn on compression:
  - ▲ On the **Scan** tab of the **Profile Settings** dialog box, select the **Use scanner compression (for optimal speed)** check box.
4. Set how much compression should be performed:
  - a. On the **Scan** tab of the **Profile Settings** dialog box, click **Advanced Settings**.
  - b. On the **More** tab of the **Properties** dialog box, move the **Scanner JPEG Compression** to the value that you want.

---

 **NOTE:** Use the ISIS or TWAIN user interface to control compression in third-party software.

---

## Filter out color from a document (color dropout)

Available color dropout options depend upon your scanner.

- **HP Scanjet 7000:** You can filter out a color channel (red, green, or blue) or up to three individual colors. For specific colors, the sensitivity setting controls how closely a scanned color must approximate the specified color.
- **HP Scanjet 5000:** You can filter out a color channel (red, green, or blue).

Removing colors from the scan might reduce the scan file size and improve optical character recognition (OCR) results.

To select colors to eliminate from a scan in an HP Smart Document Scan Software profile, follow these steps:

1. Open the HP Smart Document Scan Software.
2. Select a scan profile, and then click **Edit**.
3. On the **Scan** tab of the **Profile Settings** dialog box, click **Advanced Settings**.
4. On the **Color Dropout** tab of the **Properties** dialog box, specify the color dropout settings.

Only the color dropout options available for your scanner are selectable.

For information about the color dropout settings, see the online help for the scanning software that you are using.

---

 **NOTE:** The color channel filter only applies to grayscale scans and to black and white scans. Specific color filters apply to all color modes.

**NOTE:** Use the ISIS or TWAIN user interface to filter out color in third-party scanning software.

---

## Hardware Misfeed (Multipick) Detection

---

 **NOTE:** Hardware (Misfeed) Multipick Detection is only available on the HP Scanjet 7000. The HP Scanjet 5000 supports Software Multipick Detection.

---

The Misfeed (Multipick) Detection feature stops the scan or copy process if it senses that multiple pages are fed into the scanner at one time.

- **HP Scanjet 7000:** This feature is enabled by default.
- **HP Scanjet 5000:** Software Multipick Detect is disabled by default.

You might want to disable the Misfeed (Multipick) Detection feature if you are scanning multipart forms (a use that HP does not recommend).

To change the Misfeed (Multipick) Detection setting in an HP Smart Document Scan Software profile, follow these steps:

1. Open the HP Smart Document Scan Software.
2. Select a scan profile, and then click **Edit**.

3. On the **Scan** tab of the **Profile Settings** dialog box, click **Advanced Settings**.
4. On the **More** tab of the **Properties** dialog box:
  - Clear the **Enable** check box (located under the **Misfeed (Multipick) Detection** heading) to disable this feature.
  - Select the **Enable** check box to enable this feature.

---

# 4 Care and maintenance

This section presents information about how to care for and maintain the scanner.

- [HP Scanner Tools Utility Maintenance tab](#)
- [Order maintenance and scanning supplies](#)
- [Clean the scanner glass](#)
- [Clean the paper path](#)
- [Clean the rollers](#)
- [Replace the rollers](#)

Occasional cleaning of the scanner helps ensure high-quality scans. The amount of care necessary depends upon several factors, including the amount of use and the environment. You should perform routine cleaning as necessary.

---

△ **CAUTION:** Before placing an item in the document feeder, make sure that the item does not contain wet glue, correction fluid, or other substances that can be transferred to the interior of the scanner.

Make sure there are no curls, wrinkles, staples, paper clips, or any other attached material. Sheets should not be stuck together.

---

## HP Scanner Tools Utility Maintenance tab

The **Maintenance** tab of the HP Scanner Tools Utility displays the scanner usage, maintenance history, and settings. You can record scanner maintenance and change the setting for maintenance alerts.

For detailed information, see the HP Scanner Tools Utility Help. To open the Help, press the **Tools** button on the scanner front panel, and then click **Help** in the dialog box.

## Order maintenance and scanning supplies

You can purchase maintenance parts for your scanner.

1. Visit the HP scanner parts Web site at [www.hp.com/buy/parts](http://www.hp.com/buy/parts).
2. Select your language, and then click the arrow.

## Clean the scanner glass

Both strips of glass in the scanner should be cleaned periodically. The two small strips of gray reflective material should be lightly dusted if debris is present.

To clean the strips of glass, follow these steps:

1. Press the **Power** switch to the off position, and then disconnect the USB cable and power supply from the scanner.
2. Open the scanner hatch.

3. Clean the glass by using a soft, lint-free cloth that has been sprayed with a mild glass cleaner.

---

△ **CAUTION:** Use only glass cleaner to clean the scanner glass. Avoid cleaners that contain abrasives, acetone, benzene, and carbon tetrachloride, all of which can damage the scanner glass. Avoid isopropyl alcohol because it can leave streaks on the glass.

Do not spray the glass cleaner directly on the glass. If too much glass cleaner is applied, the cleaner could leak under the glass and damage the scanner.

---

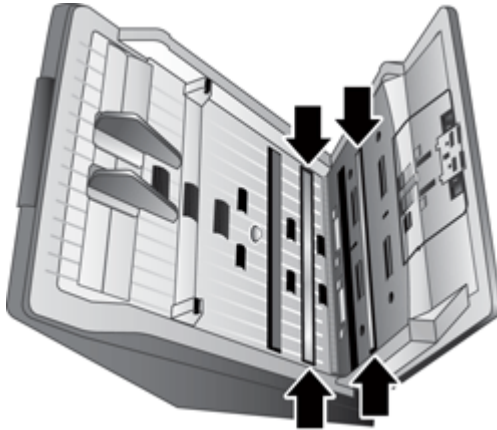

4. Dry the glass with a dry, soft, lint-free cloth.
5. With a light touch, dust the two small strips of gray reflective material with a dry, soft, lint-free cloth.
6. Close the scanner hatch, and then reconnect the USB cable and power supply to the scanner.

## Clean the paper path

If scanned images have streaks or scratches, use the HP paper-path cleaning cloth to clean the paper path.

---

 **NOTE:** If you experience repeated document jams, clean the rollers.

---

To clean the paper path, follow these steps:

1. Open the sealed HP paper-path cleaning cloth container, starting at the notch. Take care not to tear the cleaning cloth.
2. Remove the cleaning cloth and unfold it.

3. Place the unfolded cloth into the document feeder.



4. Press the **Tools** (🔧) button to open the Scanner Tools Utility. Click the **Maintenance** tab.
5. Click the **Clean** button to feed the cloth through the scanner.

---

△ **CAUTION:** Wait two minutes for the components to dry before proceeding to the next step.

---

6. Place up to five pages of printed paper in the scanner. Scan and view the results.
7. If streaks still appear, repeat steps 3 through 5. The cleaning cloth can be cycled through the scanner up to five times within 30 minutes. After that, the cloth will dry out.  
If repeated cycling of the cleaning cloth does not remove the streaks from the scanned images, clean the rollers.

## Clean the rollers

As a guideline, clean the rollers after every 5,000 scans. Note that this guideline might vary based on the type of documents you are scanning and under the following conditions:

- If cleaning the paper path did not remove the streaks or scratches from the scanned images.
- If you experience repeated document jams.

To clean the rollers, follow these steps:

1. Press the **Power** switch to the off position, and then disconnect the USB cable and power supply from the scanner.
2. Open the scanner hatch.

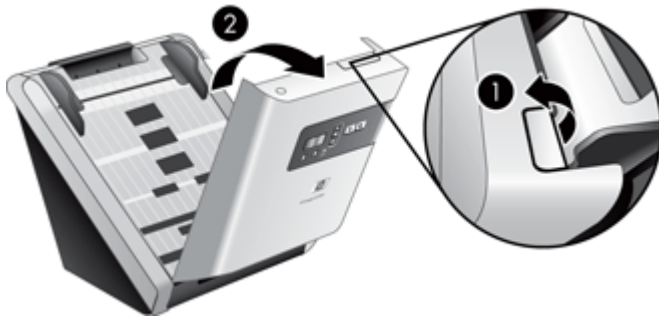

3. Open the roller cover on the inside of the scanner hatch and lift the roller up.

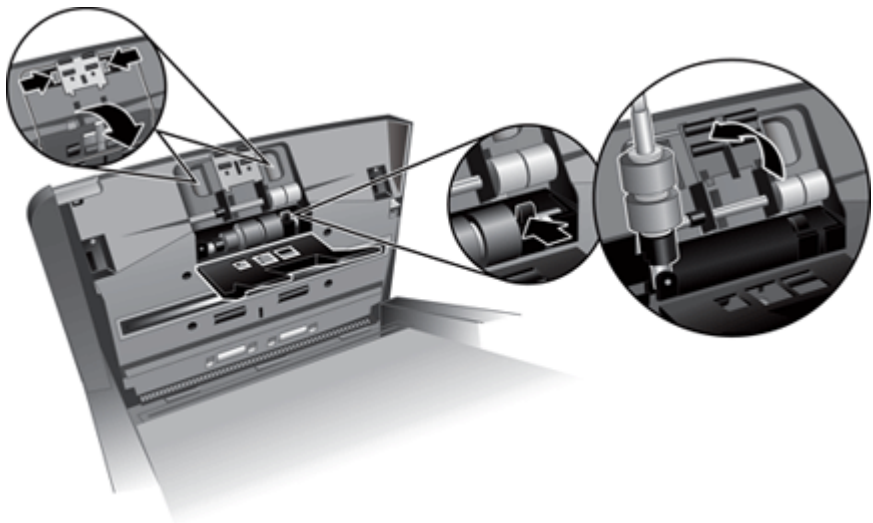

4. Remove any visible lint or dust from the roller and its housing using either compressed air or a clean lint-free cloth moistened with isopropyl alcohol.



5. Reinsert the roller into the housing.

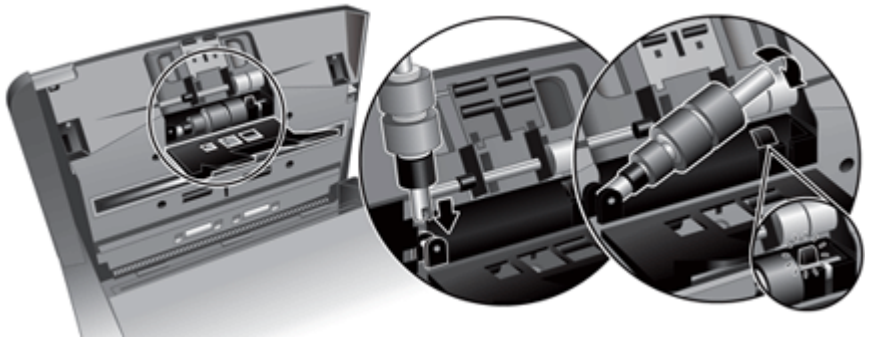

6. Open the door on the inside of the scanner, open the roller covers, and then remove the rollers.

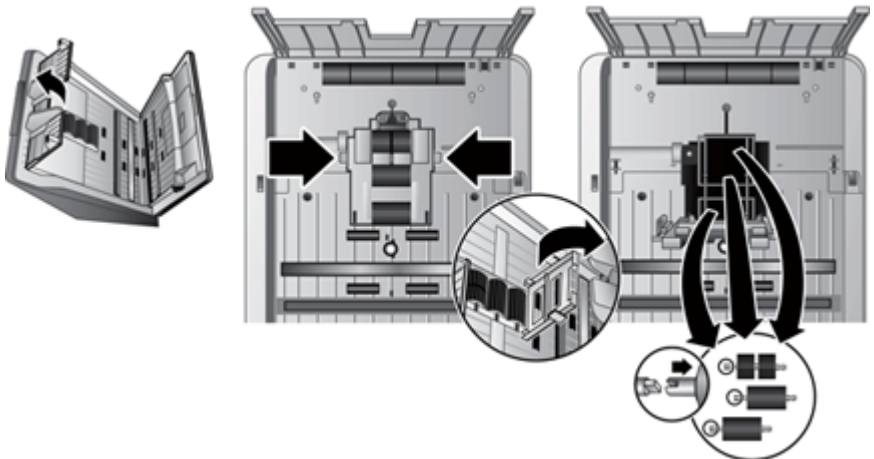

7. Remove any visible lint or dust from the rollers and their housing using either compressed air or a clean lint-free cloth moistened with isopropyl alcohol.
8. Reinsert the rollers into the housing. Rotate the rollers as you slide them to the left to match up the notches on the roller axle and axle holder. Close the roller cover door and then close the door on the inside of the scanner.

9. Clean the non-removable rollers using either compressed air or a clean lint-free cloth moistened with isopropyl alcohol.



10. Close the scanner hatch, and then reconnect the USB cable and power supply to the scanner.
11. Press the **Power** switch to the on position, and then update the scanner maintenance history:
  - a. Press the **Tools** (🔧) button on the scanner front panel to open on the HP Scanner Tools Utility.
  - b. In the **Record Cleaning** section of the **Maintenance** tab, click **Record Cleaning**.  
For more information, see the HP Scanner Tools Utility Help.

## Replace the rollers

Replace the rollers under the following conditions:

- When the **Maintenance Recommended** dialog box indicates they are due for maintenance.
- If you experience repeated document jams and cleaning the rollers did not help.

The roller replacement kit contains rollers and installation instructions. To order the replacement kit, go to [www.hp.com/support](http://www.hp.com/support).

---

 **NOTE:** The roller replacement kit is a consumable and is not covered under warranty or standard service agreements.

---

To replace the rollers, follow these steps:

1. Press the **Power** switch to the off position, and then disconnect the USB cable and power supply from the scanner.
2. Replace the rollers as described in the installation instructions that were included with the replacement kit.

3. Close the scanner hatch, and then reconnect the USB cable and power supply to the scanner.
  4. Update the scanner maintenance history:
    - a. Press the **Tools** () button on the scanner front panel to open on the HP Scanner Tools Utility.
    - b. In the **Record Replacement** section of the **Maintenance** tab, click **Record Replacement**.  
For more information, see the HP Scanner Tools Utility Help.
- 



**NOTE:** HP recommends that you replace the rollers every 100,000 scans.

The HP Scanner Tools Utility can remind you when service is needed, which depends on many conditions and might be sooner than this replacement interval.

---

# 5 Troubleshooting

This section contains solutions for common problems with the scanner.

- [Scanner error codes](#)
- [Basic troubleshooting tips](#)
- [Scanner installation troubleshooting](#)
- [Scanner initialization or hardware problems](#)
- [Scanner operation problems](#)
- [Scanner buttons are not working correctly](#)
- [Scanner paper path problems](#)
- [Contact HP Support](#)

For additional troubleshooting, see the Help for the HP scanning program that you are using.

## Scanner error codes

For help responding to an error code, see the appropriate topics below.

Error Code	Description
<b>USB Error</b>	<ol style="list-style-type: none"><li>1. Check the USB connection between the scanner and the computer.</li><li>2. Use the <b>Windows Device Manager</b> tool to verify that the computer recognizes the scanner.<ul style="list-style-type: none"><li>• <b>Windows 2000/XP/XP, 64 bit:</b> The <b>Windows Device Manager</b> tool is available on the <b>Hardware</b> tab of the <b>Systems</b> tool in the <b>Control Panel</b>.</li><li>• <b>Vista/Vista, 64 bit:</b> If you have the categorized Control Panel view, select <b>Control Panel</b>, select <b>Hardware and Sound</b>, and then select <b>Device Manager</b>. If you have the Classic view, select <b>Control Panel</b>, then select <b>Device Manager</b>.</li></ul></li><li>3. If the computer does not recognize the scanner, uninstall and then reinstall the scanner software.</li><li>4. If the problem persists, see <a href="http://www.hp.com/support">www.hp.com/support</a>.</li></ol>
<b>Paper Jam</b>	A document feeder paper jam has been detected. Open the hatch and clear the jam.
<b>Hatch Open</b>	The hatch on the document feeder is open or not securely latched. Please close the hatch by pressing until you hear a click, and then rescan.
<b>Motor Failure</b>	Press the <b>Power</b> switch to the off position. Wait 30 seconds, and then press the <b>Power</b> switch to the on position. If the message is still displayed, see <a href="http://www.hp.com/support">www.hp.com/support</a> .
<b>Lamp Error</b>	Press the <b>Power</b> switch to the off position. Wait 30 seconds, and then press the <b>Power</b> switch to the on position. If the message is still displayed, see <a href="http://www.hp.com/support">www.hp.com/support</a> .

(continued)

Error Code	Description
<b>Paper Error</b>	The document feeder cannot pick up the paper or the paper is jammed. Follow these steps to resolve the error: <ol style="list-style-type: none"><li data-bbox="522 227 1000 253">1. Remove the paper from the document feeder.</li><li data-bbox="522 256 1141 305">2. Sort through the stack to make sure the sheets are not stuck together.</li><li data-bbox="522 309 1156 357">3. Make sure the paper meets the size and weight specifications, as specified in the scanner User Guide.</li><li data-bbox="522 361 980 387">4. Replace the stack of originals and try again.</li></ol>
<b>Hardware Error</b>	Two conditions could generate this error. <ul style="list-style-type: none"><li data-bbox="522 444 1160 539">• A hardware failure occurred. Press the <b>Power</b> switch to the off position. Wait 30 seconds, and then press the <b>Power</b> switch to the on position. If the message is still displayed, see <a href="http://www.hp.com/support">www.hp.com/support</a>.</li><li data-bbox="522 543 1063 591">• The scanner requires routine maintenance. View the maintenance message on your computer screen.</li></ul>

## Basic troubleshooting tips

Simple issues such as smudges on the scanner glass or loose cables can cause your scanner to produce fuzzy scans, operate in an unexpected manner, or fail to operate. Always check the following items when you encounter scanning problems.

- If scans are fuzzy, check to see if the glass strips inside the document feeder are dirty or smudged. If so, clean the glass strips.  
If you are scanning a document using an OCR shortcut, make sure that the original document is clear and crisp enough to be scanned.
- Make sure that the USB and power cables are firmly seated in their respective connectors on the back of the scanner, and that the power cord is plugged into a working electrical outlet.
- If you have connected the scanner to the computer through a USB hub or through a USB port on the front of the computer, disconnect the scanner and then reconnect it to a USB port on the back of the computer.
- Make sure that the scanner buttons are enabled.
- Turn off the scanner, wait 60 seconds, and then turn on the scanner.
- Make sure the scanner latch is closed.
- Restart the computer.

If you continue to have problems, it is possible that your HP scanning software, firmware, or associated drivers are out of date or have become corrupted. See [www.hp.com/support](http://www.hp.com/support) to locate software, firmware, and driver updates for your scanner.

See also

- [Reset the scanner](#)
- [Check that the scanner has power](#)
- [Check the cables](#)

## Scanner installation troubleshooting

- [Check the cables](#)
- [Uninstall and then reinstall the HP Scanjet utilities](#)

### Check the cables

Cable type	Action
Power cable	<p>The power cable is connected between the scanner and a power outlet.</p> <ul style="list-style-type: none"> <li>• Ensure that the power cable is securely connected between the scanner and a live electrical outlet or surge protector.</li> <li>• If the power cable is connected to a surge protector, ensure that the surge protector is plugged into an outlet and turned on.</li> <li>• Turn off the scanner power switch and turn off the computer. After 60 seconds, turn the scanner back on and then turn on the computer, in that order.</li> </ul>
USB cable	<p>The USB cable is connected between the scanner and the computer.</p> <ul style="list-style-type: none"> <li>• Use the cable that was included with the scanner. Another USB cable might not be compatible with the scanner.</li> <li>• Ensure that the USB cable is securely connected between the scanner and the computer.</li> <li>• If the USB cable is connected to a USB port on the front of the computer, move it to a USB port on the back of the computer.</li> </ul> <p>For additional USB troubleshooting information, see <a href="http://www.hp.com/support">www.hp.com/support</a>, select your country/region, and then use the search tool to find USB troubleshooting topics.</p>

### Uninstall and then reinstall the HP Scanjet utilities

If checking the scanner cable connections did not solve the problem, the problem might have occurred because of an incomplete installation. Try uninstalling and then reinstalling the HP Scanjet utilities.

1. Press the **Power** switch to the off position, and then disconnect the USB cable and power cable from the scanner.
2. Use the **Add/Remove** tool (in Windows Vista, the **Programs and Features** tool) from the **Control Panel** to uninstall the following items:
  - **HP Scanjet 7000 Document ISIS/TWAIN** or **HP Scanjet 5000 Document ISIS/TWAIN**
  - **HP Scanjet 7000 Utilities** or **HP Scanjet 5000 Utilities**
3. Restart the computer.
4. Use the HP Scanning Software CD that came with the scanner to reinstall the HP Scanjet Drivers and Tools.
5. Reconnect the USB cable and power cable to the scanner, and then press the **Power** switch to the on position.

# Scanner initialization or hardware problems

- [Check the USB connection](#)
- [Check that the scanner has power](#)
- [Reset the scanner](#)
- [Scanner has stopped working correctly](#)

## Check the USB connection

Check the physical connection to the scanner.

- Use the cable that was included with the scanner. Another USB cable might not be compatible with the scanner.
- Ensure that the USB cable is securely connected between the scanner and the computer. The trident icon on the USB cable faces up when the cable is properly connected to the scanner.

If the problem persists after verifying the above items, try the following:

1. Do one of the following tasks depending on how the scanner is connected to the computer:
  - If the USB cable is connected to a USB hub or a docking station for a laptop, disconnect the USB cable from the USB hub or the docking station, and then connect the USB cable to a USB port on the back of the computer.
  - If the USB cable is directly connected to the computer, plug it into a different USB port on the back of the computer.
  - Remove all other USB devices from the computer except for the keyboard and the mouse.
2. Press the **Power** switch to the off position, wait 30 seconds, and then press the **Power** switch to the on position.
3. Restart the computer.
4. After the computer has restarted, try using the scanner.
  - If the scanner works, reconnect any additional USB devices one at a time; try the scanner after connecting each additional device. Disconnect any USB devices that prevent the scanner from working.
  - If the scanner does not work, uninstall and then reinstall the HP Scanjet drivers and utilities.

*See also*

[Uninstall and then reinstall the HP Scanjet utilities](#)

## Check that the scanner has power

The power cable is connected between the scanner and a power outlet.

- Ensure that the power cable is securely connected between the scanner and a live electrical outlet.
- If the power cable is connected to a surge protector, ensure that the surge protector is plugged into an outlet and turned on.

If the problem persists after verifying the above items, follow these steps:

1. Press the **Power** switch to the off position, and then disconnect the power cable from the scanner.
2. Wait 30 seconds.
3. Reconnect the power cable to the scanner, then press the **Power** switch to the on position.

See also

[Check the cables](#)

## Reset the scanner

If you receive an error message similar to **Scanner initialization failed** or **Scanner not found** when trying to use the scanner, you should reset the scanner.

To reset the scanner, follow these steps:

1. Close the HP Smart Document Scan Software and HP Scanner Tools Utility, if they are open.
2. Disconnect the USB cable that connects the scanner to the computer.
3. Turn the computer off, wait 60 seconds, and then turn on the computer.
4. Reconnect the USB cable to a USB port on the back of the computer.
  - Make sure that the USB cable is connected to the back of the scanner correctly. The trident icon on the USB cable faces up when the cable is properly connected to the scanner.
  - Try connecting the USB cable to a different USB port on the back of the computer.

## Scanner has stopped working correctly

If the scanner stops scanning, follow these steps. After each step, start a scan to see if the scanner is working. If the problem persists, proceed with the next step.

1. A cable might be loose. Ensure that both the USB cable and power supply are properly connected.

Use the cable that was included with the scanner. Another USB cable might not be compatible with the scanner.
2. Ensure that the scanner is receiving power.
  - a. Check that the green LED on the power supply case is on.
  - b. If the green LED is not on, ensure that power is available to the power outlet or surge protector that the power supply is plugged into.
  - c. If power is available to the power outlet or surge protector but the green LED is still not on, the power supply might be defective. Contact [www.hp.com/support](http://www.hp.com/support) for assistance.
3. Unplug the power cable from the power source, wait 60 seconds, and then plug it back in.
4. Restart your computer.



5. Use the **Add/Remove** tool (in Windows Vista, the **Programs and Features** tool) from the **Control Panel** to uninstall the following applications:
  - **HP Scanjet 7000 Document ISIS/TWAIN** or **HP Scanjet 5000 Document ISIS/TWAIN**
  - **HP Scanjet 7000 Utilities** or **HP Scanjet 5000 Utilities**
6. Reinstall using the HP Scanning Software CD that came with your scanner.
7. Reconnect the USB cable and power cable to the scanner, and then press the **Power** switch to the on position.

## Scanner operation problems

- [Scanner will not turn on](#)
- [Scanner lamp stays on](#)
- [Scanner does not scan right away](#)
- [Scanner scans only one side of a two-sided page](#)
- [Scanned pages are missing at the scan destination](#)
- [Scanned image is fuzzy](#)
- [Scanned pages are out of order at the scan destination](#)
- [Optimize scanning and task speeds](#)
- [The scan is completely black or completely white](#)
- [Scanned images are not straight](#)
- [Vertical white stripes appear on the printed page](#)
- [Scan files are too large](#)

### Scanner will not turn on

If the scanner will not turn on when you press the front panel scanner buttons, check the following:

- The scanner may be turned off. Be sure the **Power** switch located on the back of the scanner is in the on position.
- The scanner may have been unplugged. Check to see that the power supply has not become disconnected from the scanner or unplugged from the power source.
- The power supply might not be working.
  - Check that the green LED on the power supply case is on.
  - If the green LED is not on, ensure that power is available to the power outlet or surge protector that the power supply is plugged into.
  - If power is available to the power outlet or surge protector but the green LED is still not on, the power supply might be defective. Contact [www.hp.com/support](http://www.hp.com/support) for assistance.

### Scanner lamp stays on

The scanner lamp should time out and turn off automatically after a period of inactivity (about 15 minutes).

If the scanner lamp remains on after a long period of inactivity, turn off the scanner, wait 30 seconds, and then turn the scanner back on.

---

 **NOTE:** The scanner lamp does not turn off when paper is in the document feeder, when in **Instant Lamp On** mode, and when **Energy Savings** is turned off.

---

### Scanner does not scan right away

Make sure the scanner hatch is closed, and that the power switch on the back of the scanner is in the on position.

If the scanner has not been used for awhile, the scanner lamp might need to go through a warm-up period before scanning can begin. If the scanner lamp needs to warm up, it takes a moment after starting the software or pressing a scanner button for scanning to begin.

You can enable Instant Lamp On mode in the HP Scanner Tools Utility.

### Scanner scans only one side of a two-sided page

- When scanning using the scanner buttons, press the **Scan Duplex**  button.
- When using a scan profile for a third-party application, verify that the application supports duplex scanning.

### Scanned pages are missing at the scan destination

When scanning, pages that stick together are scanned as one item. The hidden pages are not scanned.

**HP Scanjet 7000 only:** The Misfeed (Multipick) Detection stops the scan if multiple pages are fed into the scanner at one time. To enable the Misfeed (Multipick) Detection feature in an HP Smart Document Scan Software profile, follow these steps:

1. Open the HP Smart Document Scan Software.
2. Select a scan profile, and then click **Edit**.
3. On the **Scan** tab of the **Profile Settings** dialog box, click **Advanced Settings**.
4. On the **More** tab of the **Properties** dialog box, select the **Enable** check box.

See also

[Document loading tips](#)

### Scanned image is fuzzy

Verify that the document original is not fuzzy.

**HP Scanjet 7000 only:** Use the Kofax Virtual ReScan Software which shipped with your scanner to process the scanned data. Such software cleans up the image and compresses the data.

Check for any obstructions in the scanner paper path and make sure the paper width guides are positioned appropriately. Try another scan.

Clean the glass strips inside the document feeder.

Check the JPEG compression setting. If scanner compression is high, scanned data might be lost by the compression.

See also

- [Clean the scanner glass](#)
- [Reduce file size with hardware compression](#)

## Scanned pages are out of order at the scan destination

Verify that the page order of the original document is correct before inserting into the document feeder.

Make sure that there are no staples, paper clips, or any other attached material (such as adhesive notes) that may cause the pages to feed incorrectly.

Verify that pages are not stuck together.

Place the first page of a multiple page document toward the back of the document feeder.

## Optimize scanning and task speeds

Several settings influence the total time for a scanning job. When you want to optimize scanning performance, consider the following information.

- To optimize performance, make sure your computer meets the recommended system requirements. To view minimum and recommended system requirements, see [www.hp.com](http://www.hp.com), select your country/region, search on your scanner model, and then search on **datasheet**.
- In the scanning software, choose the layout setting that matches the orientation of the originals in the document feeder.
- To optimize data transfer from the scanner to the scanning software on the computer, enable scanner hardware (JPEG) compression. Typically, the use of scanner compression reduces the time to complete all color scans and grayscale scans with resolution above 300 dpi. Scanner compression affects the rate of data transfer only and can be used with all output formats.
- If you are scanning to edit text, the optical character recognition (OCR) software requires more processing time than for non-OCR scans, which is normal. Wait for the item to scan.



**NOTE:** For the best OCR results, scanner compression should be set to the minimum compression level or disabled.

---

- Scanning at a higher resolution than necessary increases scanning time and creates a larger file with no additional benefit. If you are scanning at a high resolution, set the resolution to a lower level to increase scanning speed.

See also

- [Reduce file size with hardware compression](#)
- [Scan files are too large](#)

## The scan is completely black or completely white

The item might not be placed correctly in the document feeder. Make sure that the item you are trying to scan is placed face down.

## Scanned images are not straight

Verify that the document feeder guides are centered on the scanner and set to an appropriate width for the original being scanned. Make sure the paper guides touch the edges of the original.

## Vertical white stripes appear on the printed page

The destination printer might be out of toner or ink. Scan a different original to the same printer to see if the issue lies with the printer.

If the second scan has the same problem, try scanning to a different printer.

See also

[Clean the scanner glass](#)

## Scan files are too large

If the saved scan files are very large, try the following:

- Verify the scan resolution setting:
  - 200 dpi is sufficient for storing documents as images.
  - For most fonts, 300 dpi is sufficient for using optical character recognition (OCR) to create editable text.
  - For Asian fonts and small fonts, 400 dpi is the recommended resolution.

Scanning at a higher resolution than necessary creates a larger file with no additional benefit.

- Color scans create larger files than do black and white scans.
- If you are scanning a large number of pages at one time, consider scanning fewer pages at a time to create more, smaller files.
- **HP Scanjet 7000 only:** Use the Kofax Virtual ReScan Software which shipped with your scanner to process the scanned data. Such software cleans up the image and compresses the data, which can result in a smaller file.

See also

[Reduce file size with hardware compression](#)

## Scanner buttons are not working correctly

After each step, press a button to see if it is working correctly. If the problem persists, proceed with the next step.

1. A cable might be loose. Ensure that the USB cable and the power supply are securely connected.
2. The HP Scanner Tools Utility might have been used to disable the buttons. If so, use the HP Scanner Tools Utility to re-enable the buttons.
3. Turn off the scanner, wait 30 seconds, and then turn the scanner back on.

4. Restart your computer.
5. If the problem persists, the buttons might be disabled outside of the HP Scanner Tools Utility. Try the following procedure:
  - a. Open **Control Panel**, select **Scanners and Cameras**, and then select your scanner model from the list.
  - b. Display the scanner properties:
    - **Windows 2000:** Click **Properties**.
    - **Windows XP and Vista:** Right-click your scanner model, and then click **Properties**.
  - c. Examine the buttons setting for your scanner:
    - **Windows 2000:** Ensure that the **Disable Device Events** option is not selected.
    - **Windows XP and Vista:** Ensure the **Take No Action** option is not selected.

*See also*

[HP Scanner Tools Utility](#)

## Scanner paper path problems

- [Paper jamming, skewing, misfeeds, or multiple-page feeds](#)
- [Scanning fragile originals](#)
- [Paper does not feed from the scanner](#)
- [Originals are curling up in the scanner output tray.](#)
- [The bottom of the scanned image is cut off](#)
- [The scanned images have streaks or scratches](#)
- [An item loaded in the scanner jams repeatedly](#)
- [Clear jams from the scanner paper path](#)

### Paper jamming, skewing, misfeeds, or multiple-page feeds

- Check that all rollers are in place and that the roller doors and scanner hatch are closed.
- If the pages look skewed as they feed into the scanner paper path, check the resulting scanned images in the software to ensure that they are not skewed.
- The pages might not be placed correctly. Straighten the pages and adjust the paper guides to center the stack.
- The paper guides must be touching the sides of the paper stack to work properly. Please ensure that the paper stack is straight and the guides are against the paper stack.
- The document feeder or output tray might contain more than the maximum number of pages. Load fewer pages in the document feeder, and remove pages from the output tray.
- Clean the scanner paper path to help reduce misfeeds. If misfeeds still occur, clean the rollers. If misfeeds still occur, replace the rollers.

See also

- [Document loading tips](#)
- [Hardware Misfeed \(Multipick\) Detection](#)
- [Clean the paper path](#)
- [Clean the rollers](#)
- [Replace the rollers](#)

## Scanning fragile originals

To safely scan fragile originals (photographs or documents on wrinkled or very lightweight paper) place originals in a clear, heavyweight document sleeve that is no more than 216 mm (8.5 in) wide before inserting into the document feeder.

---

 **TIP:** If you do not have an appropriately-sized document sleeve, consider using a sheet protector intended for use in a ring binder. Trim the ring-side edge so the sleeve is no more than 216 mm (8.5 in) wide.

---

## Paper does not feed from the scanner

Re-load the pages into the document feeder, ensuring that they make contact with the rollers.

The scanner hatch might not be securely latched. Open the scanner hatch and then close it by pressing firmly.

A problem with the scanner hardware might exist. Follow this procedure to test the scanner:

1. Ensure that the power supply is securely connected between the scanner and a live electrical outlet or surge protector. Check that the green LED on the power supply case is on to verify that the power supply is functional.
2. If the power supply is connected to a surge protector, ensure that the surge protector is plugged into an outlet and turned on.
3. Disconnect the power supply from the scanner and turn off the computer. After 60 seconds, reconnect the power supply to the scanner and then turn on the computer, in that order.
4. Try to rescan.

See also

- [Clean the paper path](#)
- [Clean the rollers](#)
- [Replace the rollers](#)

## Originals are curling up in the scanner output tray.

Under dry conditions, lightweight originals such as those printed on carbonless copy paper may curl in the output tray. To minimize curl, flatten curled edges on the originals before placing them in the document feeder. If you cannot flatten curled edges, make sure the curled edges are facing down when you place the originals in the document feeder.

## **The bottom of the scanned image is cut off**

By default, the scanning software can scan media that is up to 356 mm (14 in) long. For longer pages, the end of the document is not included in the scanned image.

Verify that you have specified an appropriate page size in the scanning software.

*See also*

[Scan extra long documents](#)

## **The scanned images have streaks or scratches**

After each step, try another scan to see if the streaks or scratches are still apparent. If so, then try the next step. For information on cleaning the scanner, see the **Care and maintenance** section.

- Check that the originals are clean and unwrinkled.
- Use a cleaning cloth in the scanner paper path.
- Clean the glass strips inside the document feeder.
- Clean the rollers manually.

*See also*

[Care and maintenance](#)

## **An item loaded in the scanner jams repeatedly**

- The item might not meet the guidelines for acceptable originals.
- The item might have something on it, such as staples or self-adhesive notes on the original that must be removed.
- Make sure the paper guides touch the edges of the original.

*See also*

[Load originals](#)

## Clear jams from the scanner paper path

To clear a paper jam:

1. Open the scanner hatch.



2. Remove the originals or any obstructions from the paper path.
3. Remove any debris (paper, staples, clips, etc.) that you see in the paper path.
4. Close the scanner hatch until it snaps into place.



5. Reload the unscanned originals in the document feeder.
6. Resume scanning.

See also

[Clean the rollers](#)

[Document loading tips](#)



## Contact HP Support

For support contact information, see the printed Getting Started Guide that came with the scanner, or see [www.hp.com/support](http://www.hp.com/support).

---

# 6 Product accessibility and support

Accessibility options on this scanner include an LCD Reader and the ability to enable and disable scanner buttons.

---

 **NOTE:** The scanner User Guide is available in a Help format that is readable by most screen readers. To find this file, click **Start**, point to **Programs** or **All Programs**, point to **HP**, point to **Scanjet**, point to **7000** or **5000**, and then click **User Guide**.

---

See also

[LCD Reader](#)

[Control of the scanner buttons](#)

[Getting assistance](#)

## LCD Reader

The LCD Reader is software that outputs the status of the LCD on the scanner front panel to the computer monitor as the LCD changes. The LCD Reader enables accessibility software tools to express what is being shown on the scanner front panel.

To use the LCD Reader, follow these steps:

1. On your hard drive, navigate to C:\Program Files\Common Files\Hewlett-Packard\Scanjet\, and then to the **7000** or **5000** directory.
2. To open the program, double-click **hplcd.exe**.

---

 **NOTE:** The LCD Reader is not able to display the LCD text when there is a USB connection error or the scanner is off.

---

## Control of the scanner buttons

To prevent buttons from being pushed accidentally, you can disable the buttons on the scanner front panel.

When the buttons are disabled, you always start scans and copies from the computer using scanning software. You can still press the **Cancel (X)** button on the scanner front panel to stop a scan or copy and the **Power Save** button to put the scanner into Power Save mode.

To turn off the scanner buttons, follow these steps:

1. Open the HP Scanner Tools Utility.
2. On the **Profiles** tab, select the **Disable front panel buttons** check box.  
To turn on the scanner buttons, clear the **Disable front panel buttons** check box.



**NOTE:** You must have administrative privileges on the computer to change the setting of this check box.

---

## Getting assistance

In order to get the best results from your HP product, please consult the following HP support offerings:

1. Review the troubleshooting chapter in this guide.
2. See the HP online support website at [www.hp.com/support](http://www.hp.com/support), or contact your point of purchase.  
HP online support is available to all HP customers. It is the fastest source for up-to-date product information and expert assistance, including the following features:
  - Online chat and email access to qualified online support specialists
  - Software, firmware, and driver updates for your product
  - Valuable product and troubleshooting information for technical issues
  - Proactive product updates, support alerts, and HP newsletters (available when you register your product)
3. HP support by phone
  - Support options and fees vary by product, country/region, and language.
  - Fees and policies are subject to change without notice. Please see [www.hp.com/support](http://www.hp.com/support) for the latest information.
4. Post-warranty period  
After the limited warranty period, help is available online at [www.hp.com/support](http://www.hp.com/support).
5. Extending or upgrading your warranty  
If you would like to extend or upgrade the product's warranty, please contact your point of purchase or see the HP Care Pack Services at [www.hp.com/support](http://www.hp.com/support).
6. If you already purchased an HP Care Pack Service, please check the support conditions in your contract.

---

# Index

- A**
  - accessibility 40
  - applications
    - scan from 12
- B**
  - Back button 4
  - black scans
    - troubleshoot 33
  - blurry images 32
  - buttons
    - scanner front panel 3
- C**
  - cables
    - troubleshoot 28
  - Cancel button 4
  - Care Pack Services 41
  - clean
    - paper path 20
    - rollers 21
    - scanner glass 19
  - cleaning cloth 20
  - Color dropout 17
  - crooked images 34
  - customer support 39
  - cut-off images
    - troubleshoot 37
- D**
  - disable scanner buttons 40
  - document feeder
    - load cards 11
    - load paper 9
    - tips on loading 7
- E**
  - export profiles 15
- F**
  - features
    - color dropout 17
    - Hardware Misfeed (Multipick) Detection 17
    - long-page support 15
    - scan profiles 14
    - Scanner JPEG compression 16
    - feeding problems 35
    - fragile items, scanning 36
    - fuzzy images 32
- G**
  - glass, clean 19
- H**
  - hardware compression 16
  - Hardware Misfeed (Multipick) Detection feature 17
  - HP Care Pack Services 41
  - HP paper-path cleaning cloth 20
  - HP Scanner Tools Utility Maintenance tab 19
    - uses for 6
  - HP Smart Document Scan Software
    - scan from 12
- I**
  - import profiles 15
  - install software
    - troubleshoot 28
  - ISIS-compliant programs
    - scan from 12
- J**
  - jams
    - troubleshoot 37
- L**
  - lamp
    - troubleshoot 4, 31
  - LCD Reader 40
  - lines
    - troubleshoot 34
  - long-page support 15
- M**
  - maintenance
    - clean paper path 20
    - clean rollers 21
    - HP Scanner Tools Utility Maintenance tab 19
  - media
    - jams 37
    - misfeeds 35
    - not feeding 35
    - troubleshoot 35
  - misfeeds
    - troubleshoot 35
  - multipick detection 17
  - multiple-page feeds 35
- O**
  - OK/select button 4
  - order
    - roller replacement 24
    - supplies 19
- P**
  - pages missing, troubleshoot 32
  - pages out of order 33
  - paper
    - jams 37
    - misfeeds 35
    - not feeding 35
    - troubleshoot 35
  - paper-path
    - clean 20
    - feeding problems 35
  - parts
    - order 24
  - Power Save mode 4, 31
  - power supply
    - troubleshoot cable 28
  - product support 40
  - profiles
    - import and export 15
  - programs
    - scan from 12
- R**
  - reduce file size 16

## Index

replace rollers 24

reset scanner 30

rollers

clean 21

replace 24

## S

scan

cards 11

feeding problems 35

files too large 34

fragile items 36

from HP Smart Document

Scan Software 12

from other programs 12

paper originals 9

scan profiles 14

scanner

front panel buttons 3

reset 30

Scanner hardware

compression 16

scanner lamp

troubleshoot 4, 31

screen reader 40

skewed images 34

software

troubleshoot installation 28

uninstall and reinstall 28, 30

speed

troubleshoot 32

speed, troubleshoot 33

streaks

troubleshoot 37

stripes

troubleshoot 34

supplies

order 19

support 39, 40

## T

troubleshoot

basic tips 27

black scans 33

cables 28

check power 29

crooked images 34

cut-off images 37

feeding problems 35

fragile items 36

fuzzy images 32

installation 28

jams 37

lamp stays on 4, 31

large scan files 34

misfeeds 35

page order 33

pages missing 32

paper not feeding 35

power 31

reset scanner 30

scanning fragile items 36

speed 32, 33

stops working 30

streaks 37

two-sided scans 32

uninstall and reinstall

software 28, 30

warm-up time 4, 31

white lines 34

white scans 33

turn on scanner

troubleshoot 31

TWAIN-compliant programs

scan from 12

two-sided scans

troubleshoot 32

## U

uninstall and reinstall

software 28, 30

USB cable

troubleshoot 28

## V

vertical white stripes

troubleshoot 34

## W

warm-up time 4, 31

warranty

extended 41

Web sites

order supplies 19

replacement parts 24

white scans

troubleshoot 33

white stripes

troubleshoot 34